

## NA4900-2RSR-XL

### Needle roller bearing

Schaeffler ID:  
0507751380000

Needle roller bearings NA49..-2RSR,  
dimension series 49, lip seals on both  
sides

X-life

## Technical information

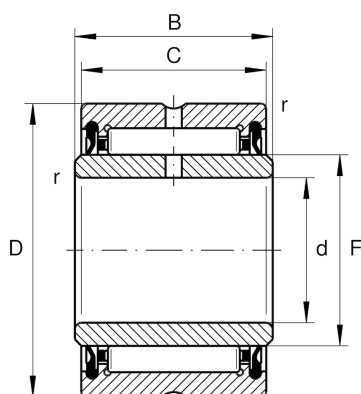

### Main Dimensions & Performance Data

d	10 mm	Bore diameter
D	22 mm	Outside diameter
B	14 mm	Width, inner ring
$C_r$	7,700 N	Basic dynamic load rating, radial
$C_{0r}$	6,900 N	Basic static load rating, radial
$C_{ur}$	1,390 N	Fatigue load limit, radial
$n_{G \text{ Grease}}$	14,800 1/min	Limiting speed for grease lubrication
	0.024 kg	Weight

### Dimensions

F	14 mm	Raceway diameter inner ring
C	13 mm	Width, outer ring
$r_{\min}$	0.3 mm	Minimum chamfer dimension

### Temperature range

$T_{\min}$	-20 °C	Operating temperature min.
$T_{\max}$	100 °C	Operating temperature max.